

Propeller Fans Axial Fans Roof Ventilators

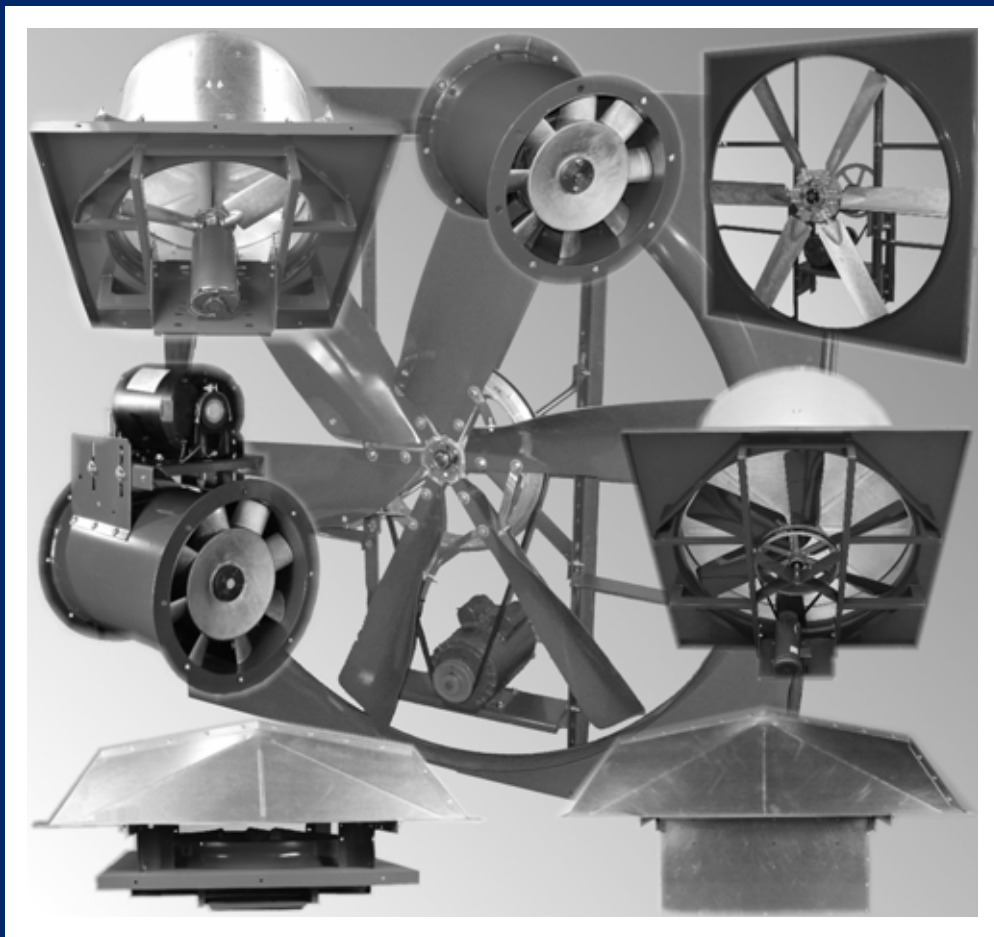

PROPELLER WALL FANS

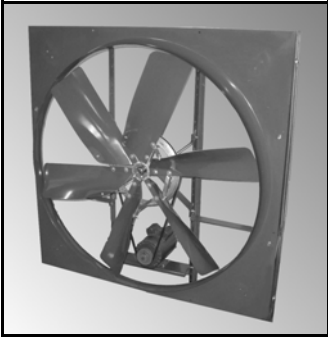

CBA - CBL - CBH - CBHX

Belt Drive

Sizes: 18" to 60"
 CFM: 2,500 to 58,800
 Static: Through 3/4"
 AMCA licensed for Sound and Air

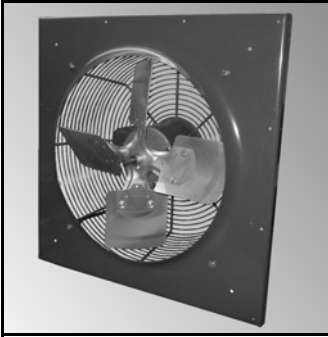

CDP - Direct Drive

Sizes: 7" to 18"
 CFM: 330 to 3,200
 Static: Through 1/4"
 AMCA licensed for Sound and Air

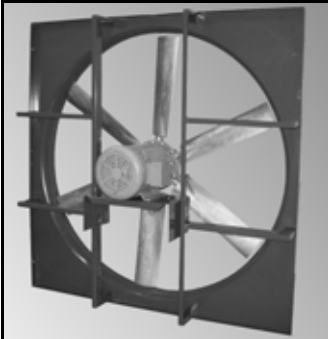

CDC - Direct Drive

Sizes: 18" to 60"
 CFM: 1,600 to 61,000
 Static: Through 3/4"
 AMCA licensed for Sound and Air

CBC - Belt Drive

Sizes: 24" TO 84"
 CFM: 4,400 TO 118,000
 Static: Through 3/4"
 AMCA licensed for Sound and Air

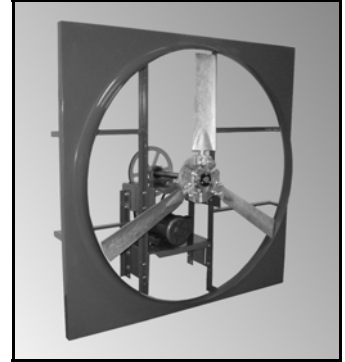

CDU - Direct Drive

Sizes: 12" TO 24"
 CFM: 900 TO 6,500
 Static: Through 1/2"
 AMCA licensed for Sound and Air

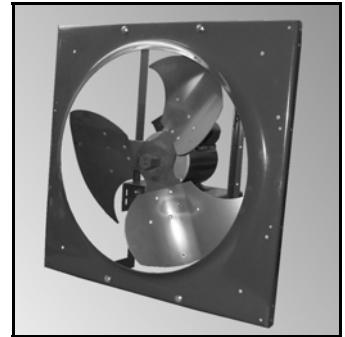

AXIAL DUCT FANS

Tube Axial



TBC - Belt Drive

Sizes: 18" to 84"
 CFM: 1,500 to 107,000
 Static: Through 2"
 AMCA licensed for Air

TEBC - Belt Drive

Sizes: 18" to 60"
 CFM: 2,600 to 52,000
 Static: Through 1-1/4"
 AMCA licensed for Sound and Air

TEBH - Belt Drive

TEDH - Direct Drive

Sizes: 12" to 24"
 CFM: 700 to 10,800
 Static: Through 1-1/4"

TDC - Direct Drive

Sizes: 18" to 60"
 CFM: 2,000 to 78,000
 Static: Through 2"
 AMCA licensed for Air

Vane Axial

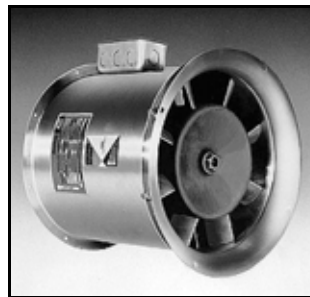

VA - VAD

Direct Drive

Sizes: 6" to 18"
 CFM: 210 to 7,200
 Static: Through 2-1/2"
 AMCA licensed for Sound and Air



VAB

Belt Drive

Sizes: 12" to 18"
 CFM: 1,000 to 6,400
 Static: Through 2-1/2"
 AMCA licensed for Sound and Air

UPBLAST ROOF VENTILATORS



JBH - JBX

Belt Drive

Sizes: 24" to 60"
 CFM: 5,600 to 57,000
 Static: Through 5/8"
 AMCA licensed for Sound and Air

JBC - Belt Drive

Sizes: 24" to 84"
 CFM: 5,600 to 118,000
 Static: Through 3/4"
 AMCA licensed for Sound and Air

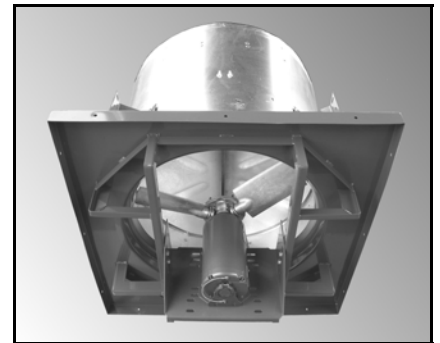

JDC - Direct Drive

Sizes: 18" to 60"
 CFM: 2,500 to 55,000
 Static: Through 3/4"
 AMCA licensed for Sound and Air

HS - Belt Drive
Heat & Smoke Ventilator
 Sizes: 18" to 84"
 CFM: 2,300 to 99,000
 Static: Through 5/8"
 AMCA licensed for Air
UL Listed for Smoke Control
(UL793)

HSE - Belt Drive
Heat & Smoke Ventilator
 Sizes: 18" to 60"
 CFM: 2,400 to 48,000
 Static: Through 5/8"
 AMCA licensed for Air and Sound
UL Listed for Smoke Control
(UL793)

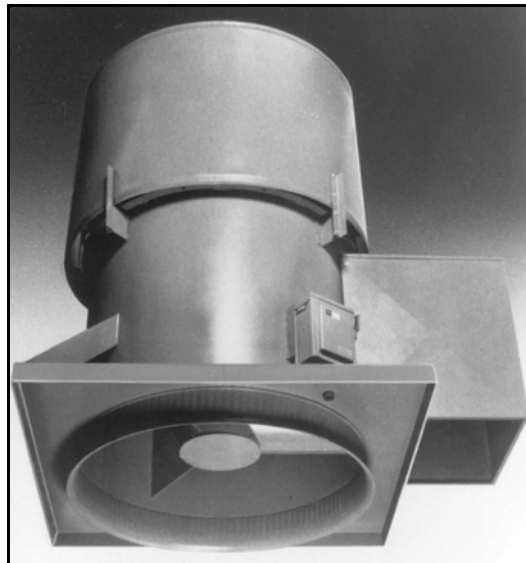

JTBC - Belt Drive
 Sizes: 18" to 84"
 CFM: 2,500 to 97,000
 Static: Through 1"
 AMCA licensed for Air

JTDC - Direct Drive
 Sizes: 18" to 60"
 CFM: 2,500 to 56,000
 Static: Through 1"
 AMCA licensed for Air

JTEBC - Belt Drive
 Sizes: 18" to 60"
 CFM: 2,500 to 51,000
 Static: Through 1"
 AMCA licensed for Sound and Air

GRAVITY ROOF VENTILATORS



LVX - LVN
Louvered Penthouse
Exhaust/Intake
 CFM: 1,500 to 104,000

TEV/TIV
Trimline Vent
Exhaust/Intake
 CFM: 1,300 to 77,000

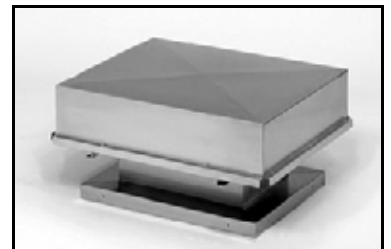

HOODED ROOF VENTILATORS

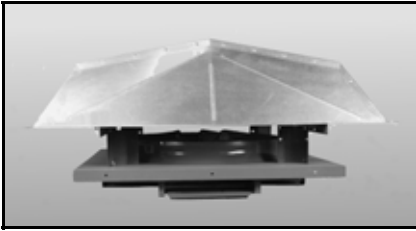

PBH - PBHX - PBC

Belt Drive Exhaust

Sizes: 24" to 84"

CFM: 3,500 to 85,000

Static: Through 3/4"

AMCA licensed for Sound and Air

PDC

Direct Drive Exhaust

Sizes: 24" to 60"

CFM: 2,900 to 39,000

Static: Through 3/4"

AMCA licensed for Sound and Air

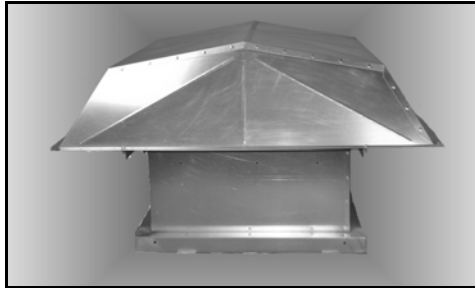

PEBH - PEBHX - PEBC

Belt Drive Exhaust

PSBH - PSBHX - PSBC

Belt Drive Supply

Sizes: 24" to 84"

CFM: 3,000 to 106,000

Static: Through 3/4"

AMCA licensed for Sound and Air

PEDC - PEUD

Direct Drive Exhaust

PSDC - PSUD

Direct Drive Supply

Sizes: 10" to 60"

CFM: 470 to 47,000

Static: Through 3/4"

PEDC & PSDC are

AMCA licensed for Sound and Air



PSBHF - PSBHXF - PSBCF

Belt Drive Filtered Supply

Sizes: 24" to 72"

CFM: 3,000 to 49,000

Static: Through 3/4"

PSDCF - PSUDF

Direct Drive Filtered Supply

Sizes: 10" to 60"

CFM: 460 to 45,000

Static: Through 3/4"

Reversible Units



REBC - Belt Drive REDC - Direct Drive Recirculation/ Exhaust

Sizes: 24" to 60"

CFM: 4,500 to 48,000

Static: Through 1/2"

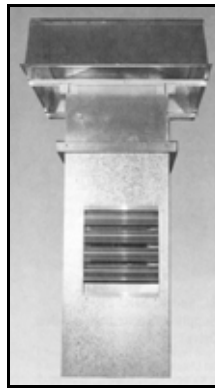

RESBC Belt Drive RESDC Direct Drive Recirculation/ Exhaust/Supply

Sizes: 24" to 60"

CFM: 2,600 to 40,000

Static: Through 1/2"

Filtered Units
Available

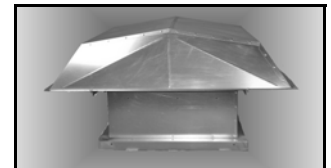

RPBC - Belt Drive RPDC - Direct Drive Exhaust/Supply

Sizes: 24" to 60"

CFM: 2,500 to 40,000

Static: Through 3/4"

OTHER PRODUCTS AVAILABLE

Mancooler Fans - Power Tube Fans - Metal Building Fan Packages -
Shutters - Roof Curbs



AMERICAN COOLAIR CORPORATION
P.O. BOX 2300 ~ Jacksonville, Florida 32203
Phone: (904) 389-3646
Fax: (904) 387-3449 or (904) 381-7560
E-mail: info@coolair.com
Website: coolair.com

REPRESENTED BY: